

Three Colors Suffice: Conflict-Free Coloring of Planar Graphs

Zachary Abel* Victor Alvarez† Erik D. Demaine‡ Sándor P. Fekete†

Aman Gour§ Adam Hesterberg* Phillip Keldenich† Christian Scheffer†

Abstract

A *conflict-free k -coloring* of a graph assigns one of k different colors to some of the vertices such that, for every vertex v , there is a color that is assigned to exactly one vertex among v and v 's neighbors. Such colorings have applications in wireless networking, robotics, and geometry, and are well-studied in graph theory. Here we study the natural problem of the *conflict-free chromatic number* $\chi_{CF}(G)$ (the smallest k for which conflict-free k -colorings exist), with a focus on planar graphs.

For general graphs, we prove the conflict-free variant of the famous Hadwiger Conjecture: If G does not contain K_{k+1} as a minor, then $\chi_{CF}(G) \leq k$. For planar graphs, we obtain a tight worst-case bound: three colors are sometimes necessary and always sufficient. In addition, we give a complete characterization of the algorithmic/computational complexity of conflict-free coloring. It is NP-complete to decide whether a planar graph has a conflict-free coloring with *one* color, while for outerplanar graphs, this can be decided in polynomial time. Furthermore, it is NP-complete to decide whether a planar graph has a conflict-free coloring with *two* colors, while for outerplanar graphs, two colors always suffice. For the bicriteria problem of minimizing the number of colored vertices subject to a given bound k on the number of colors, we give a full algorithmic characterization in terms of complexity and approximation for outerplanar and planar graphs.

1 Introduction

Coloring the vertices of a graph is one of the fundamental problems in graph theory, both scientifically and historically. Proving that four colors always suffice to color

a planar graph [5, 6, 26] was a tantalizing open problem for more than 100 years; the quest for solving this challenge contributed to the development of graph theory, but also to computers in theorem proving [29]. A generalization that is still unsolved is the *Hadwiger Conjecture* [18]: A graph is k -colorable if it has no K_{k+1} minor.

Over the years, there have been many variations on coloring, often motivated by particular applications. One such context is wireless communication, where “colors” correspond to different frequencies. This also plays a role in robot navigation, where different beacons are used for providing direction. To this end, it is vital that in any given location, a robot is adjacent to a beacon with a frequency that is unique among the ones that can be received. This notion has been introduced as *conflict-free coloring*, formalized as follows. For any vertex $v \in V$ of a simple graph $G = (V, E)$, the *closed neighborhood* $N[v]$ consists of all vertices adjacent to v and v itself. A *conflict-free k -coloring* of G assigns one of k different colors to a (possibly proper) subset $S \subseteq V$ of vertices, such that for every vertex $v \in V$, there is a vertex $y \in N[v]$, called the *conflict-free neighbor* of v , such that the color of y is unique in the closed neighborhood of v . The *conflict-free chromatic number* $\chi_{CF}(G)$ of G is the smallest k for which a conflict-free coloring exists. Observe that $\chi_{CF}(G)$ is bounded from above by the proper chromatic number $\chi(G)$ because in a proper coloring, every vertex is its own conflict-free neighbor.

Conflict-free coloring has received an increasing amount of attention. Because of the relationship to classic coloring, it is natural to investigate the conflict-free coloring of planar graphs. In addition, previous work has considered either general graphs and hypergraphs (e.g., see [25]) or geometric scenarios (e.g., see [20]); we give a more detailed overview further down. This adds to the relevance of conflict-free coloring of planar graphs, which constitute the intersection of general graphs and geometry. In addition, the subclass of outerplanar graphs is of interest, as it corresponds to subdividing simple polygons by chords.

*Mathematics Department, MIT, Cambridge, Massachusetts, USA

†Algorithms Group, TU Braunschweig, Braunschweig, Germany

‡Computer Science and Artificial Intelligence Laboratory, MIT, Massachusetts, USA

§Computer Science and Engineering, IIT Bombay, Mumbai, India

There is a spectrum of different scientific challenges when studying conflict-free coloring. What are worst-case bounds on the necessary number of colors? When is it NP-hard to determine the existence of a conflict-free k -coloring, when polynomially solvable? What can be said about approximation? Are there sufficient conditions for more general graphs? And what can be said about the bicriteria problem, in which also the number of colored vertices is considered? We provide extensive answers for all of these aspects, basically providing a complete characterization for planar and outerplanar graphs.

1.1 Our contribution. We present the following results.

1. For general graphs, we provide the conflict-free variant of the Hadwiger Conjecture: If G does not contain K_{k+1} as a minor, then $\chi_{CF}(G) \leq k$.
2. It is NP-complete to decide whether a planar graph has a conflict-free coloring with *one* color. For outerplanar graphs, this question can be decided in polynomial time.
3. It is NP-complete to decide whether a planar graph has a conflict-free coloring with *two* colors. For outerplanar graphs, two colors always suffice.
4. Three colors are sometimes necessary and always sufficient for conflict-free coloring of a planar graph.
5. For the bicriteria problem of minimizing the number of colored vertices subject to a given bound $\chi_{CF}(G) \leq k$ with $k \in \{1, 2\}$, we prove that the problem is NP-hard for planar and polynomially solvable in outerplanar graphs.
6. For planar graphs and $k = 3$ colors, minimizing the number of colored vertices does not have a constant-factor approximation, unless $P = NP$.
7. For planar graphs and $k \geq 4$ colors, it is NP-complete to minimize the number of colored vertices. The problem is fixed-parameter tractable (FPT) and allows a PTAS.

1.2 Related work. In a geometric context, the study of conflict-free coloring was started by Even, Lotker, Ron, and Smorodinsky [15] and Smorodinsky [27], who motivate the problem by frequency assignment in cellular networks: There, a set of n base stations is given, each covering some geometric region in the plane. The base stations service mobile clients that can be at any point in the total covered area. To

avoid interference, there must be at least one base station in range using a unique frequency for every point in the entire covered area. The task is to assign a frequency to each base station minimizing the number of frequencies. On an abstract level, this induces a coloring problem on a hypergraph where the base stations correspond to the vertices and there is an hyperedge between some vertices if the range of the corresponding base stations has a non-empty common intersection.

If the hypergraph is induced by disks, Even et al. [15] prove that $\mathcal{O}(\log n)$ colors are always sufficient. Alon and Smorodinsky [4] extend this by showing that each family of disks, where each disk intersects at most k others, can be colored using $\mathcal{O}(\log^3 k)$ colors. Furthermore, for unit disks, Lev-Tov and Peleg [23] present an $\mathcal{O}(1)$ -approximation algorithm for the number of colors. Horev et al. [21] extend this by showing that any set of n disks can be colored with $\mathcal{O}(k \log n)$ colors, even if every point must see k distinct unique colors. Abam et al. [1] discuss the problem in the context of cellular networks where the network has to be reliable even if some number of base stations fault, giving worst-case bounds for the number of colors required.

For the dual problem of coloring a set of points such that each region from some family of regions contains at least one uniquely colored point, Har-Peled and Smorodinsky [19] prove that with respect to every family of pseudo-disks, every set of points can be colored using $\mathcal{O}(\log n)$ colors. For rectangle ranges, Elbassioni and Mustafa [14] show that it is possible to add a sub-linear number of points such that a conflict-free coloring with $\mathcal{O}(n^{3/8 \cdot (1+\epsilon)})$ colors becomes possible. Ajwani et al. [2] complement this by showing that coloring a set of points with respect to rectangle ranges is always possible using $\mathcal{O}(n^{0.382})$ colors. For coloring points on a line with respect to intervals, Cheilaris et al. [10] present a 2-approximation algorithm, and a $(5 - \frac{2}{k})$ -approximation algorithm when every interval must see k uniquely colored vertices. Hoffman et al. [20] give tight bounds for the conflict-free chromatic art gallery problem under rectangular visibility in orthogonal polygons: $\Theta(\log \log n)$ are sometimes necessary and always sufficient. Chen et al. [13] consider the online version of the conflict-free coloring of a set of points on the line, where each newly inserted point must be assigned a color upon insertion, and at all times the coloring has to be conflict-free. Also in the online scenario, Bar-Nov et al. [9] consider a certain class of k -degenerate hypergraphs which sometimes arise as intersection graphs of geometric objects, presenting an online algorithm using $\mathcal{O}(k \log n)$ colors.

On the combinatorial side, some authors consider the variant in which all vertices need to be colored; note

that this does not change asymptotic results for general graphs and hypergraphs: it suffices to introduce one additional color for vertices that are left uncolored in our constructions. Regarding general hypergraphs, Ashok et al. [7] prove that maximizing the number of conflict-freely colored edges in a hypergraph is FPT when parameterized by the number of conflict-free edges in the solution. Cheilaris et al. [11] consider the case of hypergraphs induced by a set of planar Jordan regions and prove an asymptotically tight upper bound of $\mathcal{O}(\log n)$ for the conflict-free list chromatic number of such hypergraphs. They also consider hypergraphs induced by the simple paths of a planar graph and prove an upper bound of $\mathcal{O}(\sqrt{n})$ for the conflict-free list chromatic number. For hypergraphs induced by the paths of a simple graph G , Cheilaris and Tóth [12] prove that it is coNP-complete to decide whether a given coloring is conflict-free if the input is G . Regarding the case in which the hypergraph is induced by the neighborhoods of a simple graph G , which resembles our scenario, Pach and Tárdoš [25] prove that the conflict-free chromatic number of an n -vertex graph is in $\mathcal{O}(\log^2 n)$. Glebov et al. [17] extend this from an extremal and probabilistic point of view by proving that almost all $G(n, p)$ -graphs have conflict-free chromatic number $\mathcal{O}(\log n)$ for $p \in \omega(1/n)$, and by giving a randomized construction for graphs having conflict-free chromatic number $\Theta(\log^2 n)$. In more recent work, Gargano and Rescigno [16] show that finding the conflict-free chromatic number for general graphs is NP-complete, and prove that the problem is FPT w.r.t. vertex cover or neighborhood diversity number.

2 Preliminaries

For every vertex $v \in V$, the *closed neighborhood* is denoted by $N_G[v] := N_G(v) \cup \{v\}$. A partial k -coloring of G is an assignment $\chi : V' \rightarrow \{1, \dots, k\}$ of colors to a subset $V' \subseteq V(G)$ of the vertices. χ is called *conflict-free k -coloring* of G iff, for each vertex $v \in V$, there is a vertex $w \in N_G[v] \cap V'$ such that $\chi(w)$ is unique in $N_G[v]$, i.e., for all other $w' \in N_G[v] \cap V'$, $\chi(w') \neq \chi(w)$. We call w the conflict-free neighbor of v .

In order to avoid confusion with *proper k -colorings*, i.e., colorings that color all vertices such that no adjacent vertices receive the same color, we use the term *proper coloring* when referring to this kind of coloring. The minimum number of colors needed for a proper coloring of G , also known as the chromatic number of G , is denoted by $\chi_P(G)$, whereas the minimum number of colors required for a conflict-free coloring of G (G 's *conflict-free chromatic number*) is written as $\chi_{CF}(G)$. Note that, because every vertex sees itself, every proper coloring of G is also a conflict-free coloring of G , and

thus $\chi_{CF}(G) \leq \chi_P(G)$. For some k , we define the *conflict-free domination number* $\gamma_{CF}^k(G)$ of G to be the minimum number of vertices that have to be colored in a conflict-free k -coloring of G . We set $\gamma_{CF}^k(G) = \infty$ if G is not conflict-free k -colorable. Because the set of colored vertices is a dominating set, the conflict-free domination number satisfies $\gamma_{CF}^k(G) \geq \gamma(G)$ for all k , where $\gamma(G)$, the domination number of G , is the size of a minimum dominating set of G . Moreover, for any graph, there is a $k \leq \gamma(G)$ such that $\gamma_{CF}^k(G) = \gamma(G)$.

We denote the complete graph on n vertices by $K_n := (\{1, \dots, n\}, \{\{u, v\} \mid u, v \in \{1, \dots, n\}, u \neq v\})$, and the complete bipartite graph on n and m vertices as $K_{n,m}$. We define the graph $K_n^{-3} := (V(K_n), E(K_n) \setminus E(K_3))$, which is obtained by removing *any* three edges forming a single triangle from a K_n .

We also provide a number of results for outerplanar graphs. An outerplanar graph is a graph that has a planar embedding for which all vertices belong to the outer face of the embedding. An outerplanar graph is called *maximal* iff no edges can be added to the graph without losing outerplanarity [8]. Maximal outerplanar graphs can also be characterized as the graphs having an embedding corresponding to a polygon triangulation, which illustrated the particular relevance in a geometric context. In addition, maximal outerplanar graphs exhibit a number of interesting graph-theoretic properties. Every maximal outerplanar graph is chordal, a 2-tree and a series-parallel graph. Also, every maximal outerplanar graph is the visibility graph of a simple polygon.

For some of our NP-hardness proofs, we use a variant of the planar 3-SAT problem, called POSITIVE PLANAR 1-IN-3-SAT. This problem was introduced and shown to be NP-complete by Mulzer and Rote [24], and consists of deciding whether a given positive planar 3-CNF formula allows a truth assignment such that in each clause, exactly one literal is true.

DEFINITION 2.1. (POSITIVE PLANAR FORMULAS)

A formula ϕ in 3-CNF is called *positive planar* iff it is both positive and backbone planar. A formula ϕ is called *positive* iff it does not contain any negation, i.e. iff all occurring literals are positive. A formula ϕ , with clause set $C = \{c_1, \dots, c_l\}$ and variable set $X = \{x_1, \dots, x_n\}$, is called *backbone planar* iff its associated graph $G(\phi) := (X \cup C, E(\phi))$ is planar, where $E(\phi)$ is defined as follows:

- $x_i c_j \in E(\phi)$ for a clause $c_j \in C$ and a variable $x_i \in X$ iff x_i occurs in c_j ,
- $x_i x_{i+1} \in E(\phi)$ for all $1 \leq i < n$.

The path formed by the latter edges is also called the backbone of the formula graph $G(\phi)$.

3 Conflict-Free Coloring of General Graphs

In this section we consider the CONFLICT-FREE k -COLORING problem on general simple graphs. In Section 3.1, we prove that this problem is NP-complete for any $k \geq 1$. In Section 3.2, we provide a sufficient criterion that guarantees conflict-free k -colorability. In Section 3.3, we consider the conflict-free domination number and prove that, for any $k \geq 3$, there is no constant-factor approximation algorithm for γ_{CF}^k .

3.1 Complexity

THEOREM 3.1. CONFLICT-FREE k -COLORING is NP-complete for any fixed $k \geq 1$.

Membership in NP is clear. For $k \geq 3$, we prove NP-hardness using a reduction from proper k -COLORING. For $k \in \{1, 2\}$, refer to Section 4, where we prove CONFLICT-FREE k -COLORING of planar graphs to be NP-complete for $k \in \{1, 2\}$.

Central to the proof is the following lemma that enables us to enforce certain vertices to be colored, and both ends of an edge to be colored using distinct colors.

LEMMA 3.2. Let G be any graph, $u, v \in V(G)$ and $vu = e \in E(G)$. If $N(v)$ contains two disjoint and independent copies of a graph H with $\chi_{CF}(H) = k$, not adjacent to any other vertex $w \in G$, every conflict-free k -coloring of G colors v . If the same holds for u and in addition, $N_G(u) \cap N_G(v)$ contains two disjoint and independent copies of a graph J with $\chi_{CF}(J) = k - 1$, not adjacent to any other vertex $w \in G$, every conflict-free k -coloring of G colors u and v with different colors.

Proof. Assume towards a contradiction that there was a conflict-free k -coloring χ that avoids coloring v . Then, due to the copies of H being independent, disjoint and not connected to any other vertex, the restriction of χ to the vertices of each of the two copies must induce a conflict-free coloring on H . As $\chi_{CF}(H) = k$, this implies that χ uses k colors on each copy. Therefore, in the open neighborhood of v , there are at least two vertices colored with each color. This leads to a contradiction, because v cannot have a conflict-free neighbor.

For the second proposition, suppose there was a conflict-free coloring assigning the same color to u and v . Without loss of generality, let this color be 1. As every vertex of the two copies of J now sees two occurrences of color 1, color 1 can not be the color of the unique neighbor of any vertex of J , and any occurrence of color 1 on the vertices of J can be removed. Therefore, we

can assume each of the two copies of J to be colored in a conflict-free manner using the colors $\{2, \dots, k\}$. Observe that, due to $\chi_{CF}(J) = k - 1$, each of these colors must be used at least once in each copy. This implies that both u and v see each color at least twice: The two copies of J enforce two occurrences of the colors $\{2, \dots, k\}$, and color 1 is assigned to both u and v , which are connected by an edge. This is a contradiction, and therefore, both u and v must be colored with distinct colors. \square

Next, we give an inductive construction of graphs, G_k , with $\chi_{CF}(G_k) = k$. The proof of NP-hardness relies on this hierarchy.

1. The first graph G_1 of the hierarchy consists of a single isolated vertex. G_2 is a $K_{1,3}$ with one edge subdivided by another vertex, or, equivalently, a path of length 3 with a leaf vertex attached to one of the inner vertices.
2. Given G_k and G_{k-1} , G_{k+1} is constructed as follows for $k \geq 2$:
 - Take a complete graph $G = K_{k+1}$ on $k + 1$ vertices.
 - To each vertex $v \in V(K_{k+1})$, attach two disjoint and independent copies of G_k , adding an edge from v to every vertex of both copies of G_k .
 - For each edge $e = vw \in E(K_{k+1})$, add two disjoint and independent copies of G_{k-1} , adding an edge from v and w to every vertex of both copies.

The number of vertices of the graphs G_k obtained by the above construction satisfies the recursive formula

$$|G_1| = 1, |G_2| = 5, |G_{k+1}| = (k+1) \cdot (2|G_k| + k|G_{k-1}| + 1),$$

which is in $\Omega(2^k)$ and $\mathcal{O}(2^{k \log k})$. Figure 1 depicts the graph G_3 , which in addition to being planar is a series-parallel graph.

LEMMA 3.3. For G_k constructed in this manner, $\chi_{CF}(G_k) = k$.

Proof. The proof uses induction over k . Application of Lemma 3.2 implies that all vertices of the K_{k+1} underlying G_{k+1} have to be colored using different colors. Therefore, $\chi_{CF}(G_{k+1}) \geq k + 1$. By coloring all $k + 1$ vertices of the underlying K_{k+1} with a different color, we obtain a conflict-free $(k + 1)$ -coloring of G_{k+1} , implying $\chi_{CF}(G_{k+1}) \leq k + 1$. \square

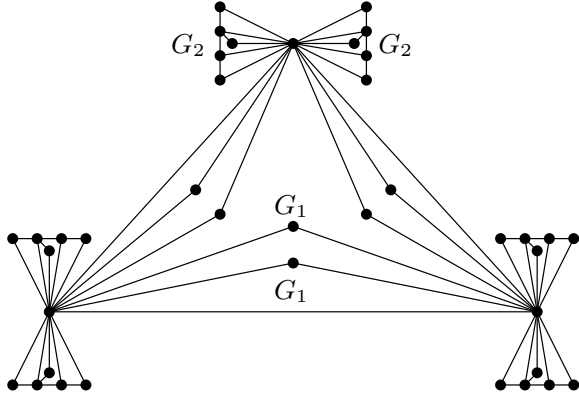

Figure 1: The graph G_3 .

LEMMA 3.4. For $k \geq 2$, k -COLORING \preceq CONFLICT-FREE k -COLORING. Therefore, for $k \geq 3$, CONFLICT-FREE k -COLORING is NP-complete.

Proof. Given a graph G for which to decide proper k -colorability for a fixed k . We construct a graph G' that is conflict-free k -colorable iff G is k -colorable. G' is constructed from G by attaching two copies of G_k to each vertex $v \in V(G)$, by adding an edge from v to each vertex of the copies of G_k . For each edge $uv \in E(G)$, we attach two copies of G_{k-1} to both endpoints of uv by adding an edge from u and v to all vertices of both copies. As k is fixed, $|G_k|$ and $|G_{k-1}|$ are constant, implying that G' can be constructed in polynomial time.

A proper k -coloring of G induces a conflict-free k -coloring of G' by leaving all other vertices uncolored. On the other hand, by Lemma 3.2, a conflict-free k -coloring χ of G' colors all vertices $v \in V(G)$ and for every edge, the colors of both endpoints are distinct. Therefore, the restriction of χ to $V(G)$ is a proper k -coloring of G . \square

3.2 A Sufficient Criterion for k -Colorability.

In this section we present a sufficient criterion for conflict-free k -colorability together with an efficient heuristic that can be used to color graphs satisfying this criterion with k colors in a conflict-free manner. This heuristic is called *iterated elimination of distance-3-sets* and is detailed in Algorithm 1. The main idea of this heuristic is to iteratively compute maximal sets of vertices at pairwise (link) distance at least 3, coloring all vertices in one of these sets using one color, and then removing these vertices and their neighbors until all that remains is a collection of disconnected paths, which can then be colored using one color.

THEOREM 3.5. Let G be a graph and $k \geq 1$. If G has neither K_{k+2} nor K_{k+3}^{-3} as a minor, G admits a

conflict-free k -coloring that can be found in polynomial time using iterated elimination of distance-3 sets.

Proof. For $k = 1$, a graph G with neither a K_3 nor a $K_4^{-3} = K_{1,3}$ minor consists of a collection of isolated paths. A path on $3n$ vertices can be colored with one color by coloring the middle vertex of every three vertices. This does not color the vertices at either end, so up to two vertices can be removed from the path to get colorings for paths on $3n - 1$ and $3n - 2$ vertices.

For $k \geq 2$, we use induction as follows: First, we color an inclusion-wise maximal subset $D \subseteq V$ of vertices at pairwise distance at least 3 to each other using color 1. This provides a conflict-free neighbor of color 1 to every vertex in $N[D]$. Therefore, the vertices in $N[D]$ are covered and can be removed from the graph. The remaining graph consists of vertices at distance 2 to some vertex in D ; we call these vertices *unseen* in the remainder of the proof. We show that the remaining graph has no K_{k+1} and no K_{k+2}^{-3} as a minor. By induction, iterated elimination of distance 3 sets requires $k - 1$ colors to color the remaining graph, and thus k colors suffice for G .

If the graph is disconnected, iterated elimination of distance 3 sets works on all components separately, so we can assume G to be connected. We claim that there is no set U of unseen vertices that is a cutset of G . Suppose there were such a cutset U and let H be any component of $G \setminus U$ not containing v , the first selected vertex during the construction of D . At least one vertex of H is colored: every vertex in U is at distance at least two from every colored vertex not in H , therefore, every vertex in H is at distance at least three from every colored vertex not in H . Consider the iteration where the first vertex w of H is added to the set of colored vertices D . At this point, w is at distance exactly 3 from some colored vertex not in H . However, this implies w is adjacent to some vertex from U , contradicting the fact that all vertices in U are unseen.

Now, suppose for the sake of contradiction that the set W of unseen vertices contains a K_{k+1} or K_{k+2}^{-3} minor. W is not the whole graph, because at least one vertex is colored, so there must be a vertex v not in the K_{k+1} or K_{k+2}^{-3} minor. For every vertex $w \in W$, there is a path from v to w that intersects W only at w . Otherwise, $W \setminus \{w\}$ would be a cutset separating v from w . So, if the graph induced by W had a K_{k+1} or K_{k+2}^{-3} minor, we could contract $G \setminus W$ to a single vertex, which would be adjacent to all vertices in W , yielding a K_{k+2} or K_{k+3}^{-3} minor of G , which does not exist. \square

Observe that G_{k+1} contains a K_{k+3}^{-3} as a minor, but not a K_{k+2} , proving that just excluding K_{k+2} as a minor does not suffice to guarantee k -colorability. Moreover,

Algorithm 1 Iterated elimination of distance-3-sets

```
1:  $i \leftarrow 1, \chi \leftarrow \emptyset$ 
2: Remove all isolated paths from  $G$ 
3: while  $G$  is not empty do
4:    $D \leftarrow \emptyset$ 
5:   For each component of  $G$ , select some vertex  $v$  and add it to  $D$ 
6:   while there is a vertex  $w$  at distance  $\geq 3$  from all vertices in  $D$  do
7:     Choose  $w$  at distance exactly 3 from some vertex in  $D$ 
8:      $D \leftarrow D \cup \{w\}$ 
9:    $\forall u \in D : \chi(u) \leftarrow i$ 
10:   $i \leftarrow i + 1$ 
11:  Remove  $N[D]$  from  $G$ 
12:  Remove all isolated paths from  $G$ 
13: Color all removed isolated paths using color  $i$ 
```

note that K_{k+1} is a minor of K_{k+2} and K_{k+3}^{-3} . This yields the following corollary, which is the conflict-free variant of the Hadwiger Conjecture.

COROLLARY 3.6. *All graphs that do not have K_{k+1} as a minor are conflict-free k -colorable.*

3.3 Conflict-Free Domination Number. In this section we consider the problem of minimizing the number of colored vertices in a conflict-free k -coloring for a fixed k , which is equivalent to computing γ_{CF}^k . We call the corresponding decision problem k -CONFLICT-FREE DOMINATING SET. We show that approximating the conflict-free domination number in general graphs is hard for any fixed k . In Section 5 we discuss the k -CONFLICT-FREE DOMINATING SET problem for planar graphs.

THEOREM 3.7. *Unless $P = NP$, for any $k \geq 3$, there is no polynomial-time approximation algorithm for $\gamma_{CF}^k(G)$ with constant approximation factor.*

Proof. We use a reduction from proper k -COLORING for the proof. Assume towards a contradiction that there was a polynomial-time approximation algorithm for $\gamma_{CF}^k(G)$ with approximation factor $c \geq 1$. Let G be a graph on n vertices for which we want to decide k -colorability. For each vertex v of G , add $M := (n+1)(c+1)$ vertices u_v to G and connect them to v . For each edge vw of G , add M vertices u_{vw} to G and connect them to both v and w . Let G' be the resulting graph. Clearly, the size of G' is polynomial in the size of G . Additionally, G' is planar if G is, and G' has a conflict-free k -coloring of size n iff G is properly k -colorable: Any proper k -coloring of G is a conflict-free k -coloring of G' , as every vertex added to G is either adjacent to two distinctly colored vertices of

G , or adjacent to just one vertex of G . Conversely, let χ be a conflict-free coloring of G' , coloring just n vertices. If χ did not assign a color to some vertex v of G , it would have to color all $M \geq n+1$ neighbors of v . If χ assigned the same color to any pair v, w of vertices adjacent in G , it would have to color all M vertices adjacent only to v and w . Therefore, χ is a proper coloring of G . Running a c -approximation algorithm on G' results in a conflict-free coloring using at most $c \cdot n < M$ vertices if G is k -colorable, and using at least M vertices if G is not; thus we could decide k -colorability in polynomial time. \square

4 Planar Conflict-Free Coloring

This section deals with the PLANAR CONFLICT-FREE k -COLORING problem which consists of deciding conflict-free k -colorability for fixed k on planar graphs. Due to the 4-color theorem, we immediately know that every planar graph is conflict-free 4-colorable. This naturally leads to the question of whether there are planar graphs requiring 4 colors or whether fewer colors might already suffice for a conflict-free coloring, which we address in the following two sections.

4.1 Complexity. For $k \in \{1, 2\}$ colors, we show that the problem of deciding conflict-free k -colorability on planar graphs is NP-complete. This implies that 2 colors are not sufficient.

THEOREM 4.1. *Deciding planar conflict-free 1-colorability is NP-complete.*

Proof. Membership in NP is obvious. The proof of NP-hardness is done by reduction from the problem POSITIVE PLANAR 1-IN-3-SAT. From a positive planar 3-CNF formula ϕ with clauses $C = \{c_1, \dots, c_l\}$ and variables $X = \{x_1, \dots, x_n\}$ we construct in polynomial

time a graph $G_1(\phi)$ such that ϕ is 1-in-3-satisfiable iff $G_1(\phi)$ admits a conflict-free 1-coloring.

First, find and fix a planar embedding d of $G(\phi)$. $G_1(\phi)$ is constructed from $G(\phi)$ and d as follows: For every variable x_i , there is a cycle $Z_i = (z_{i,1}, \dots, z_{i,12})$ of length 12. The vertices $z_{i,1}, z_{i,4}, z_{i,7}, z_{i,10}$ are referred to as *true* vertices of Z_i , all other vertices are *false* vertices. Moreover, vertices $z_{i,1}, z_{i,2}, z_{i,3}$ are called *upper* vertices of Z_i , and vertices $z_{i,7}, z_{i,8}, z_{i,9}$ are called *lower* vertices of Z_i . Additionally, vertices $z_{i,4}, z_{i,5}, z_{i,6}$ are called *right* vertices of Z_i and $z_{i,10}, z_{i,11}, z_{i,12}$ are called *left* vertices of Z_i .

For each clause c_j , there is a cycle $(c_{j,1}, \dots, c_{j,4})$ of length 4 in $G_1(\phi)$. To each variable x_i for $i \in \{2, \dots, n-1\}$, we associate two disjoint sequences $U_i = (u_j)_{j=1}^{|U_i|}$ and $L_i = (l_j)_{j=1}^{|L_i|}$ of clauses x_i appears in. The sequences are constructed using a clockwise (with respect to d) enumeration of the edges of x_i in $G(\phi)$, starting with $x_{i-1}x_i$. Let $(x_{i-1}x_i, x_i c_{j_1}, \dots, x_i c_{j_\lambda}, x_i x_{i+1}, x_i c_{j_{\lambda+1}}, \dots, x_i c_{j_\mu})$ be the sequence of edges encountered in this manner and set $U_i := (c_{j_1}, \dots, c_{j_\lambda})$ and $L_i := (c_{j_{\lambda+1}}, \dots, c_{j_\mu})$. For $i \in \{1, n\}$, L_i is empty and U_i contains all clauses x_i appears in, again in clockwise order. In $G_1(\phi)$, the clauses and variables are connected such that for each clause c_j that x_i occurs in, either the upper or the lower *true* vertex of x_i is adjacent to $c_{j,1}$. More precisely, for variable x_i , if $c_j = u_m$, we add the edge $c_{j,1}z_{i,1}$ to connect the upper true vertex to the clause. If $c_j = l_m$, we add $c_{j,1}z_{i,7}$ to connect the lower true vertex to the clause. Because the order of edges around each vertex is preserved by the construction, the graph $G_1(\phi)$ obtained in this way can be embedded in the plane by a suitable adaptation of d . See Figure 2 for an example of the construction.

Now we prove that $G_1(\phi)$ is conflict-free 1-colorable iff ϕ is 1-in-3-satisfiable. Regarding necessity, a valid truth assignment $b : X \rightarrow \mathbb{B}$ yields a valid conflict-free coloring by coloring the vertex $c_{j,3}$ of every clause, coloring all true vertices of variables with $b(x_i) = 1$ and coloring the false vertices $z_{i,3}, z_{i,6}, z_{i,9}, z_{i,12}$ of all other variables. Thus, in every cycle Z_i , every third vertex is colored, providing a conflict-free neighbor to every vertex of Z_i . Moreover, in each clause, by virtue of $c_{j,3}$ being colored, vertices $c_{j,2}, c_{j,3}, c_{j,4}$ have a conflict-free neighbor. Because b is a valid truth assignment, for each clause, the vertex $c_{j,1}$ is adjacent to exactly one colored true vertex. Therefore, the coloring constructed in this way is conflict-free.

Regarding sufficiency, we first argue that the vertices $c_{j,1}, c_{j,2}, c_{j,4}$ can never be colored: If $c_{j,1}$ receives a color, then $c_{j,3}$ still enforces that one of $c_{j,2}, c_{j,3}, c_{j,4}$ is colored, leading to a contradiction in either case. If

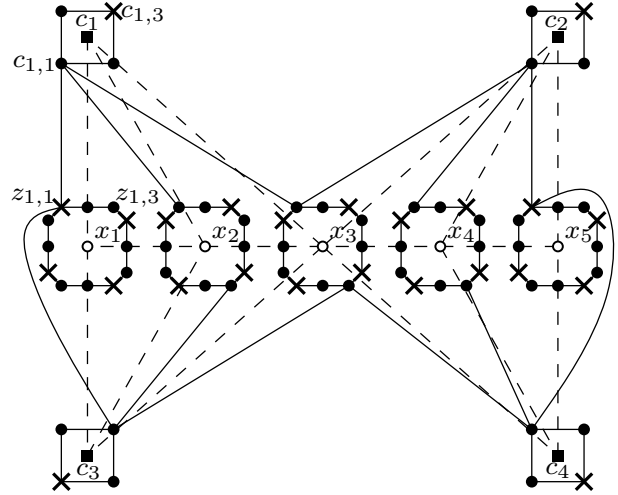

Figure 2: A formula graph $G(\phi)$ (dashed) and the corresponding $G_1(\phi)$ (solid).

$c_{j,2}$ receives a color, then $c_{j,4}$ cannot have a conflict-free neighbor and vice versa. Therefore, no clause vertex can be the conflict-free neighbor of any vertex of Z_i . Thus, the conflict-free neighbor of *every* vertex of Z_i must itself be a vertex of Z_i . Moreover, the conflict-free neighbor of every vertex $c_{j,1}$ must be a true vertex. Thus, there are exactly three ways to color each cycle Z_i : either by coloring the true vertices (one possibility), or by coloring every other false vertex (two possibilities). A valid conflict-free 1-coloring of $G_1(\phi)$ satisfies the property that for each clause c_j , exactly one of the true vertices adjacent to $c_{j,1}$ is colored. Hence, a valid conflict-free 1-coloring of $G_1(\phi)$ induces a valid truth assignment b by setting $b(x_i) = 1$ iff all true vertices of x_i are colored. \square

THEOREM 4.2. *It is NP-complete to decide whether a planar graph admits a conflict-free 2-coloring.*

The proof requires the gadget $G_{\leq 1}$ depicted in Figure 3. $G_{\leq 1}$ consists of three vertices v, w_1, w_2 forming a triangle. Each edge ux of the triangle has two corresponding vertices y_{ux}^1, y_{ux}^2 , each connected to u and x . Furthermore, both w_1 and w_2 are attached to two copies of a cycle on 4 vertices, where every vertex of both cycles is adjacent to the corresponding w_i . $G_{\leq 1}$ can be used to enforce that the vertices connected to its central vertex v are colored using at most one distinct color:

LEMMA 4.3. *Let $G = (V, E)$ be any graph, let $v \in V$ and let G' be the graph resulting from adding a copy of $G_{\leq 1}$ to G by identifying v in G with v in $G_{\leq 1}$. Then (1) G' is planar if G is, and (2) every conflict-free 2-coloring of G' leaves v uncolored and uses at most one color on $N_G[v]$.*

Proof. The planarity of G' follows from the planarity of G by the observation that $G_{\leq 1}$ is planar and can be embedded in any face incident to v in a planar embedding of G . Now consider a conflict-free 2-coloring χ of G' . χ must color both w_1 and w_2 . Otherwise, χ restricted to each of the two 4-cycles adjacent to w_i must be a valid conflict-free 2-coloring. However, as C_4 requires at least 2 different colors, w_i then sees two occurrences of both colors, and thus cannot have a conflict-free neighbor anymore. Furthermore, $\chi(w_1) \neq \chi(w_2)$, as otherwise, $y_{w_1 w_2}^1$ and $y_{w_1 w_2}^2$ must both be colored with the other color; but then, w_1 and w_2 again see two occurrences of both colors. By an analogous argument, χ must not color v . Moreover, χ cannot use more than one color on $N_G[v]$, because v already sees one occurrence of each color, so adding another occurrence of both colors would yield a conflict at v . \square

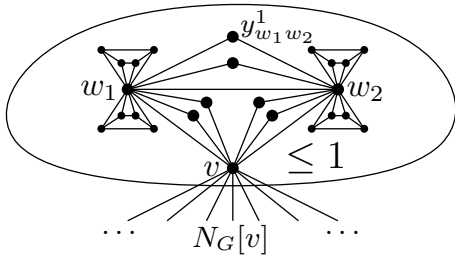

Figure 3: Gadget $G_{\leq 1}$

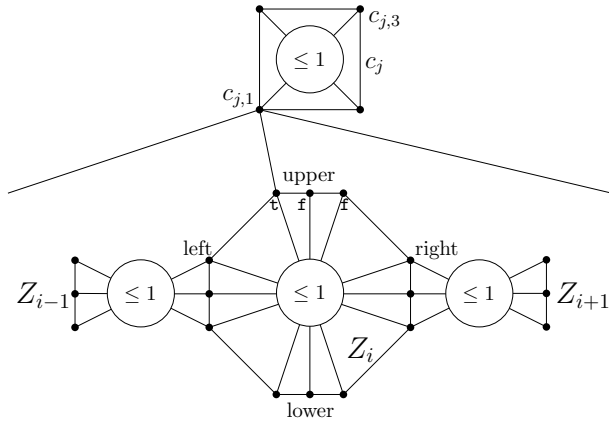

Figure 4: Clause and variable gadget for $k = 2$

Proof. [Proof of Theorem 4.2] NP-hardness is proven by constructing, in polynomial time, a planar graph $G_2(\phi)$ from the graph $G_1(\phi)$ used in the hardness proof for $k = 1$, such that $G_2(\phi)$ is conflict-free 2-colorable iff $G_1(\phi)$ is conflict-free 1-colorable.

The construction is carried out by adding a gadget $G_{\leq 1}$ to every variable cycle Z_i of $G_1(\phi)$, to every clause

cycle and between the right and left vertices of two adjacent variable cycles Z_i and Z_{i+1} . This is depicted in Figure 4. More precisely, for every cycle Z_i , we add one copy of gadget $G_{\leq 1}$, and connect its central vertex v to all vertices of the cycle. In a planar embedding of $G_2(\phi)$, these gadgets can be embedded within the face defined by the cycles Z_i and thus do not harm planarity. By Lemma 4.3, this enforces that on every cycle, only one color can be used. Moreover, for every edge $x_i x_{i+1}$ in $G(\phi)$, we add one copy of $G_{\leq 1}$ that we connect to the right vertices of x_i and the left vertices of x_{i+1} . This preserves planarity because these gadgets and the added edges can be embedded in the face crossed by $x_i x_{i+1}$ in some fixed embedding d of $G(\phi)$. As one of the right vertices of x_i and one of the left vertices of x_{i+1} must be colored, this enforces that the same single color must be used to color all cycles Z_i . Finally, we add a copy of $G_{\leq 1}$ to every clause c_j and connect it to $c_{j,1}, \dots, c_{j,4}$. Again, this preserves planarity because the gadget may be embedded in the face defined by $(c_{j,1}, \dots, c_{j,4})$.

We now argue that $G_2(\phi)$ is conflict-free 2-colorable iff $G_1(\phi)$ is conflict-free 1-colorable. A 1-coloring of $G_1(\phi)$ induces a 2-coloring of $G_2(\phi)$ by copying the color assignment and coloring the internal vertices of the added gadgets as described in the proof of Lemma 4.3. Now, let $G_2(\phi)$ be conflict-free 2-colorable and fix a valid 2-coloring χ . In each clause, χ must color $c_{j,3}$ and neither of $c_{j,1}, c_{j,2}$ nor $c_{j,4}$ can be colored. Therefore, no clause vertex can be the conflict-free neighbor of any vertex of Z_i . Thus, the conflict-free neighbor of every vertex of Z_i must itself be a vertex of Z_i . Moreover, the conflict-free neighbor of every vertex $c_{j,1}$ must be a true vertex. As there is only one color available to color all cycle vertices of all variables, the restriction of χ to the vertices of $G_1(\phi)$ yields a valid 1-coloring except for the fact that some $c_{j,3}$ might use a different color than the one used for the variables. However, this can be fixed by simply replacing all occurring colors with one single color. Hence, $G_2(\phi)$ is conflict-free 2-colorable iff $G_1(\phi)$ is conflict-free 1-colorable. \square

4.2 Sufficient Number of Colors. As shown above, it is NP-complete to decide whether a planar graph has a conflict-free k -coloring for $k \in \{1, 2\}$. On the positive side, we can establish the following result, which follows from the more general results discussed in Section 3.2.

COROLLARY 4.4. (OF THEOREM 3.5) *Every outerplanar graph is conflict-free 2-colorable and every planar graph is conflict-free 3-colorable. Moreover, such colorings can be computed in polynomial time.*

Outerplanar graphs are not the only interesting graph class for which one might suspect two colors to be sufficient. Two other interesting subclasses of planar graphs are series-parallel graphs and pseudo-maximal planar graphs. However, each of these classes contains graphs that do not admit a conflict-free 2-coloring: The graph G_3 as defined in Section 3 is an example of a series-parallel graph requiring three colors. Figure 5 depicts a maximal outerplanar graph O_9 satisfying $\chi_{CF}(O_9) = 2$. This graph can be used to obtain a pseudomaximal planar graph M with $\chi_{CF}(M) = 3$ by adding two copies of O_9 to the neighborhood of every vertex of a triangle, similar to the construction of G_3 , and adding gadgets on the inside of the triangle as depicted in Figure 6.

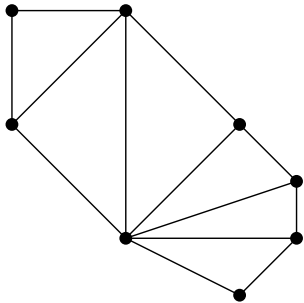

Figure 5: The maximal outerplanar graph O_9 .

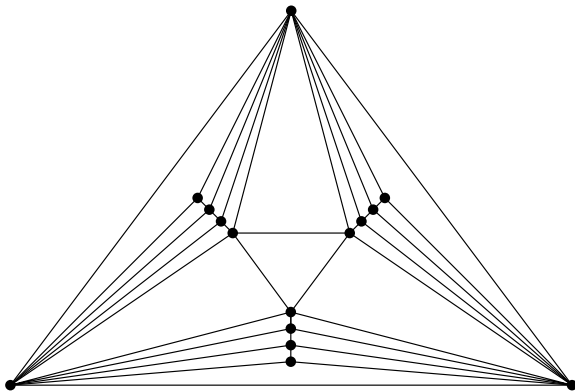

Figure 6: The pseudomaximal planar graph M , without the O_9 gadgets.

Furthermore, observe that Theorem 4.4 does not hold if every vertex must be colored. In this case, there are outerplanar graphs requiring 3 colors for a conflict-free coloring. One can obtain an example of such a graph by adding a chord to a cycle of length 5.

5 Minimizing the Number of Colored Vertices in Planar Graphs

In this section we consider the decision problem k -CONFLICT-FREE DOMINATING SET for planar graphs. In Section 5.1, we deal with the cases when $k \in \{1, 2\}$ for planar and outerplanar graphs, and we give a polynomial time algorithm to compute an optimal conflict-free coloring of outerplanar graphs with $k \in \{1, 2\}$ colors. Section 5.2 discusses the problem for $k \geq 3$.

5.1 At Most Two Colors. We start by pointing out that, for every conflict-free 1-colorable graph G , $\gamma_{CF}^1(G) = \gamma(G)$ holds. Moreover, Corollary 5.1 discusses the complexity of k -CONFLICT-FREE DOMINATING SET and Theorem 5.2 states positive results for outerplanar graphs.

COROLLARY 5.1. (OF THEOREMS 4.1 AND 4.2)
 k -CONFLICT-FREE DOMINATING SET is NP-complete for $k \in \{1, 2\}$ for planar graphs.

THEOREM 5.2. Let $k \in \{1, 2\}$ and let G be an outerplanar graph. We can decide in polynomial time whether $\chi_{CF}(G) \leq k$. Moreover, we can compute a conflict-free k -coloring of G that minimizes the number of colored vertices in $\mathcal{O}(n^{4k+1})$ time.

The proof of Theorem 5.2 relies on a polynomial-time algorithm that computes a k -coloring of the input outerplanar graph G if and only if such a coloring exists (which thus solves the decision problem). In the following, we describe our algorithm.

Let $G = (V, E)$ be an outerplanar graph. Let $\chi : V' \subseteq V(G) \rightarrow \{0, 1, \dots, k\}$ be a partial coloring of the vertices of G and let $v \in V$. Observe that χ defined like this differs from the definition given earlier in the introduction. We call a pair $\mathcal{C}_v = [\chi(v), S_v]$ a *configuration* of v , where $\chi(v) \in \{0, 1, \dots, k\}$ denotes the color of v . If $\chi(v) = 0$, we regard v as uncolored. The set $S_v \subseteq N[v]$ is the set of conflict-free neighbors of v , along with their colors. That is, every $w \in S_v$ is a *conflict-free neighbor* of v under χ . For $e = uv \in E$ we call a pair $\mathcal{C}_e = [\mathcal{C}_u, \mathcal{C}_v]$ a *configuration* of e . By \mathcal{C}_e^w we denote the configuration of an endpoint $w \in \{u, v\}$ of e . Observe that if χ was conflict-free, then $S_v \neq \emptyset$, and \mathcal{C}_u and \mathcal{C}_v do not *conflict* with each other. For the latter property we say that \mathcal{C}_u and \mathcal{C}_v are *compatible* and we denote this by $\mathcal{C}_u \leftrightarrow \mathcal{C}_v$. If $\mathcal{C}_e^v = \mathcal{C}_e^u$ for a pair $e = uv, e' = vw$ of incident edges, then we say $\mathcal{C}_{e'}$ is *compatible with* \mathcal{C}_e . The following observation is straightforward:

OBSERVATION 5.3. Let G be an outerplanar graph. Let $\mathcal{C} = \{\mathcal{C}_1, \dots, \mathcal{C}_{|E|}\}$ be a set of configurations over the

edges of G using k colors. If for every pair $e = uv$, $e' = vw$ of incident edges, $\mathcal{C}_u \leftrightarrow \mathcal{C}_v$ and $\mathcal{C}_v \leftrightarrow \mathcal{C}_w$ holds and $\mathcal{C}_{e'}$ is compatible with \mathcal{C}_e , then a conflict-free k -coloring can be obtained from \mathcal{C} .

Now let $v \in V(G)$. Observe that the number of different configurations $\mathcal{C}_v = [\chi(v), S_v]$ is upper-bounded by $O(n^k)$, as there cannot be more than $\binom{|N[v]|}{k} \cdot k!$ different sets S_v . Thus the following observation is straightforward.

OBSERVATION 5.4. *Let $G = (V, E)$ be an outerplanar graph and let $e = uv \in E$. The number of different configurations $\mathcal{C}_e = [\mathcal{C}_u, \mathcal{C}_v]$ is upper-bounded by $O(n^{2k})$.*

We can now describe our algorithm, which is based on non-serial dynamic programming. For the sake of simplicity, let us assume that the weak dual $G^* = (V^*, E^*)$ of the outerplanar graph G is connected. This means that G^* is a tree. It is well-known that, in general, the weak dual graph of an outerplanar graph G is a forest [28]. We discuss later how to convert this forest into a tree as long as G is connected.

Let us root G^* at an arbitrary dual vertex $r \in V^*$. Thus, each dual vertex has a unique parent vertex on the path from the vertex to r . For an edge $e = vw \in E^*$, where v is the parent of w , we consider the subtree \mathcal{T}_e rooted at w . Let G_e be the primal subgraph of G whose dual graph is \mathcal{T}_e .

We define a *window* b as the edge or vertex in the primal graph G separating two faces f_1, f_2 . Observe that b corresponds to an edge e in the dual graph G^* . If f_1^* and f_2^* are two (dual) vertices in the dual graph, then the corresponding faces f_1 and f_2 only have b in common, see Figure 7. Assume that f_2 has been conflict-free k -colored. Then, to color f_1 in a conflict-free manner, we would need all the possible configurations of the window b allowed by the conflict-free coloring of the face f_2 . The algorithm performs dynamic programming starting by computing *all* possible configurations of the leaves of G^* and propagating them towards the root in a compatible manner (conflict-freely).

Let f be a face of G and f^* be the corresponding dual vertex in G^* . Let b be the window of f and let $e = b^*$ be the dual edge of b connecting f^* to its parent $p = p(f^*)$. For any configuration \mathcal{C}_b , we compute the score $\mathcal{S}(\mathcal{C}_b)$, which is the number of colored vertices corresponding to \mathcal{C}_b in the conflict-free k -coloring of the subgraph G_e . We store the pairs $(\mathcal{C}_w, \mathcal{S}(\mathcal{C}_w))$ which are then combined with the other children of p to compute the compatible configurations of p . Given a window w of a face f_l , the algorithm GENERATESCORE computes $\mathcal{S}(\mathcal{C}_w)$ for a given configuration \mathcal{C}_w . Let f_l

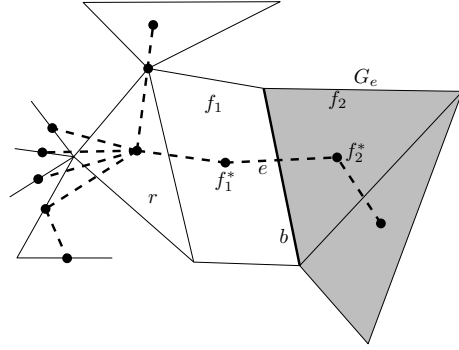

Figure 7: Graph construction of faces, windows, and the corresponding dual (sub)graphs. The shaded area corresponds to already processed faces of G (the past). The face f_1 is the face to be processed next (the present). Edge b is the window between f_1 and f_2 . The rest of the graph corresponds to faces to be processed in the future.

consist of the edges $\langle e_1 = (u_1, v_1), \dots, e_\ell = (u_\ell, v_\ell) \rangle$ where, without loss of generality, $w = e_1$ if w is an edge. Otherwise $w = u_1$ if w is a vertex. Also, let $L(e_i)$ be the set of all possible configurations of the edge e_i . By $\mathcal{C}_{u_1}^S$ we denote the number of conflict-free neighbors of u_1 given the configuration \mathcal{C}_{u_1} , i.e., if $\mathcal{C}_{u_1} = (\chi(u_1), S_{u_1})$, then $\mathcal{C}_{u_1}^S = |S_{u_1}|$. The algorithm populates a family $\{P_i\}$ of sets containing pairs of compatible configurations and their scores. In the algorithm GENERATESCORE, $\delta(\mathcal{C}_{e_i}, \mathcal{C}_{e_{i-1}})$ is the number of newly-colored vertices resulting from combining the two compatible configurations \mathcal{C}_{e_i} and $\mathcal{C}_{e_{i-1}}$.

LEMMA 5.5. *For a fixed $k \geq 1$, we can compute the scores $\mathcal{S}(\mathcal{C}_b)$ for all configurations \mathcal{C}_b of all windows b in $\mathcal{O}(n^{4k+1})$ time.*

Proof. We process the dual graph G^* starting from the leaves. Let b be the window between the two faces f_1 and f_2 . The window corresponds to an edge between a dual vertex and its parent in the dual graph. Let $f_1 = \langle e_1 = (u_1, v_1), \dots, e_\ell = (u_\ell, v_\ell) \rangle$ such that $e_1 = b$, $v_\ell = u_1$, and $v_i = u_{i+1}$ for $i \in \{1, \dots, \ell - 1\}$. We compute $\mathcal{S}(\mathcal{C}_b)$ by applying Algorithm 2. Inductively, we can compute the score for all configurations of all windows going up in the dual graph in this manner.

For each window there are at most $\mathcal{O}(n^{2k})$ configurations. This implies that for each pair of edges, there are at most $\mathcal{O}(n^{4k})$ pairs of configurations. As Algorithm 2 considers $\mathcal{O}(n)$ pairs of edges overall, we obtain a running time of $\mathcal{O}(n^{4k+1})$ for the algorithm. \square

Proof. [Proof of Theorem 5.2] By applying the approach of Algorithm 2 we can compute the scores of all windows

Algorithm 2 Processing a configuration of a window

```

1: function GENERATESCORE( $\mathcal{C}_{e_1}, f = \langle e_1 = (u_1, v_1), \dots, e_\ell = (u_\ell, v_\ell) \rangle$ )
2:    $P_1 \leftarrow \{(\mathcal{C}_{e_1}, \mathcal{C}_{u_1}^S)\}$ 
3:   for  $i = 2, \dots, \ell$  do
4:      $P_i \leftarrow \emptyset$ 
5:     for  $(\mathcal{C}_{e_{i-1}}, h) \in P_{i-1}$  do
6:       for  $\mathcal{C}_{e_i} \in L(e_i)$  do
7:         if  $\mathcal{C}_{e_{i-1}}$  is compatible with  $\mathcal{C}_{e_i}$  then
8:            $P_i \leftarrow P_i \cup \{(\mathcal{C}_{e_i}, h + \delta(\mathcal{C}_{e_i}, \mathcal{C}_{e_{i-1}}))\}$ 
9:    $\mathcal{S}(\mathcal{C}_{e_1}) \leftarrow \infty$ 
10:  for  $(\mathcal{C}_{e_\ell}, h) \in P_\ell$  do
11:    if  $\mathcal{C}_{e_\ell}$  is compatible with  $\mathcal{C}_{e_1}$  then
12:       $\mathcal{S}(\mathcal{C}_{e_1}) \leftarrow \min\{\mathcal{S}(\mathcal{C}_{e_1}), h\}$ 

```

of the graph G . At the root node we have a set of configuration for each window that results in the minimum number of colored vertices in the whole graph. Such a set can be obtained by backtracking. Combining this with Observation 5.3, we get a conflict-free coloring with a minimal number of colored vertices for the graph G , if and only if $\chi_{CF}(G) \leq k$. \square

What remains to be discussed is how we treat the case in which G^* is not a tree but a forest (assuming G is connected). The dual G^* becomes disconnected if G has cut edges or cut vertices. In such a case, we use the following construction depicted in Figure 8 to connect the components of G^* to obtain a tree.

- (1) For a cut vertex v , let $\langle f_1, \dots, f_t \rangle$ be the t faces containing v . Let $\langle f_1^*, \dots, f_t^* \rangle$ be the corresponding vertices in G^* . We make one of f_i^* a parent to all the others by adding an edge between them. Note that this does not create a cycle because G is outerplanar.
- (2) If we have a cut edge, we consider the cut edge as a face. In this way, for a cut edge, we have a vertex in the dual graph.

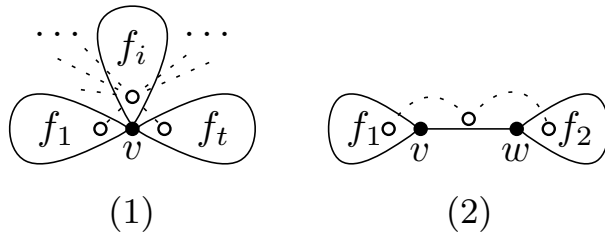

Figure 8: Two cases leading to a forest: (1) a cut vertex, (2) a cut edge.

5.2 Approximability for Three or More Colors.

In Section 4.2 we stated that every planar graph is conflict-free 3-colorable. In this section we deal with conflict-free 3-colorings of planar graphs that, additionally, minimize the number of colored vertices.

THEOREM 5.6. *Let $k \geq 3$ and let G be a planar graph. The following holds:*

- (1) *Unless $P = NP$, there is no polynomial-time approximation algorithm providing a constant-factor approximation of $\gamma_{CF}^3(G)$ for planar graphs. 3-CONFLICT-FREE DOMINATING SET is NP-complete for planar graphs.*
- (2) *For $k \geq 4$, k -CONFLICT-FREE DOMINATING SET is NP-complete. Also, $\gamma_{CF}^k(G) = \gamma(G)$, and the problem is fixed-parameter tractable with parameter $\gamma_{CF}^k(G)$. Furthermore, there is a PTAS for $\gamma_{CF}^k(G)$.*
- (3) *If G is outerplanar, then $\gamma_{CF}^k(G) = \gamma(G)$ and there is a linear-time algorithm to compute $\gamma_{CF}^k(G)$.*

The proof of Theorem 5.6 is based on the following polynomial-time algorithm, which transforms a dominating set D of a planar graph G into a conflict-free k -coloring of G , coloring only the vertices of D : Let D be a dominating set of a planar graph G . Every vertex $v \in V(G) \setminus D$ is adjacent to at least one vertex in D . Pick any such vertex $u \in D$ and contract the edge $uv \in E(G)$ towards u . Repeat this until only the vertices from D remain. Because G is planar, the graph $G' = (D, E')$ obtained in this way is planar, as G' is a minor of G . By the 4-coloring theorem, we can compute a proper 4-coloring of G' .

LEMMA 5.7. *The 4-coloring generated by this procedure induces a conflict-free 4-coloring of G .*

Proof. Every vertex $u \in D$ is a conflict-free neighbor to itself as its color does not appear in $N_G(u)$. Let $v \in V(G) \setminus D$ be some uncolored vertex, and let $u \in D$ be the vertex that v was contracted towards by the algorithm. In G' , this contraction made u adjacent to all other vertices in $N_G(v) \cap D$, which guarantees that the color of u is unique in $N_G(v) \cap D$. As $V(G) \setminus D$ remains uncolored, the color of u is thus unique in $N_G[v]$. \square

Proof. [Proof of Theorem 5.6] Proposition (1) follows from Theorem 3.7 of Section 3.3: The reduction used there preserves planarity and proper planar 3-coloring is NP-complete. For (2), $\gamma_{CF}^k(G) = \gamma(G)$ implies NP-hardness in planar graphs because planar minimum dominating set is NP-hard. Moreover, the coloring algorithm lets us apply any approximation scheme for planar dominating set to conflict-free k -coloring. We obtain a PTAS for the conflict-free domination number by applying our coloring algorithm to the dominating set produced by the PTAS of Baker and Hill [8]. Additionally, Alber et al. [3] proved that planar dominating set is FPT with parameter $\gamma(G)$, implying that computing the planar conflict-free domination number for $k \geq 4$ is FPT with parameter $\gamma_{CF}^k(G)$. For (3), the class of outerplanar graphs is properly 3-colorable in linear time and closed under taking minors. Kikuno et al. [22] present a linear time algorithm for finding a minimum dominating set in a series-parallel graph, which includes outerplanar graphs. The result follows by combining this linear time algorithm with the coloring algorithm mentioned above, but using just three colors instead of four. \square

6 Conclusion

A spectrum of open questions remain. Many of them are related to general graphs, in particular with our sufficient condition for general graphs. For every $k \geq 2$, G_{k+1} provides an example that excluding K_{k+2} as a minor is not sufficient to guarantee k -colorability. However, for $k \geq 2$ we have no example where excluding K_{k+3}^- as a minor does not suffice.

Variants of our problems arise from modifying the considered neighborhoods. In our definition of the neighborhood $N[v]$ of a vertex $v \in V$, we allow the vertex itself to serve as the one that is uniquely colored. In some settings (e.g., for guiding a robot to other locations), it is also interesting to require that *another* vertex must be uniquely colored. This distinction has been dubbed “closed” neighborhood ($N[v]$, including v) and “open” neighborhood ($N(v)$, excluding v) by Gargano and Rescigno [16]. It would be interesting to expand our positive results to the case of open neighborhoods; another proof of NP-completeness seems straightforward. Another distinction arises from requiring that *all* ver-

tices must be colored. It is clear that one extra color suffices for this purpose; however, it is not always clear that this is also necessary, in particular, for planar graphs. Adapting our argument to this situation does not seem straightforward, especially since there are outerplanar graphs requiring three colors in this setting.

In addition, there is a large set of questions related to geometric versions of the problem. What is the worst-case number of colors for straight-line visibility graphs within simple polygons? It is conceivable that $\Theta(\log \log n)$ is the right answer, just like for rectangular visibility, but this is still an open problem, just like complexity and approximation. Other questions arise from considering geometric intersection graphs, such as unit-disk intersection graphs, for which necessary and sufficient conditions, just like upper and lower bounds, would be quite interesting.

Acknowledgments

We thank Bruno Crepaldi, Pedro de Rezende, Cid de Souza, Stephan Friedrichs, Michael Hemmer and Frank Quedenfeld for helpful discussions. Work on this paper was partially supported by the DFG Research Unit “Controlling Concurrent Change”, funding number FOR 1800, project FE407/17-2, “Conflict Resolution and Optimization”.

References

- [1] M. A. Abam, M. de Berg, and S.-H. Poon. Fault-tolerant conflict-free colorings. In *Proc. 20th Canadian Conference on Computational Geometry (CCCG’08)*, pages 13–16, 2008.
- [2] D. Ajwani, K. Elbassioni, S. Govindarajan, and S. Ray. Conflict-free coloring for rectangle ranges using $O(n^{.382})$ colors. In *SPAA ’07: Proc. 19th ACM Symposium on Parallelism in Algorithms and Architectures*, pages 181–187, 2007.
- [3] J. Alber, M. R. Fellows, and R. Niedermeier. Polynomial-time data reduction for dominating set. *Journal of the ACM*, 51(3):363–384, 2004.
- [4] N. Alon and S. Smorodinsky. Conflict-free colorings of shallow discs. In *Proc. 22nd Annual Symposium on Computational Geometry*, pages 41–43. ACM, 2006.
- [5] K. Appel and W. Haken. Every planar map is four colorable. Part I. Discharging. *Illinois J. Math.*, 21:429–490, 1977.
- [6] K. Appel and W. Haken. Every planar map is four colorable. Part II. Reducibility. *Illinois J. Math.*, 21:491–567, 1977.
- [7] P. Ashok, A. Dudeja, and S. Kolay. Exact and FPT algorithms for max-conflict free coloring in hypergraphs. In *Proc. 26th International Symposium on Algorithms and Computation*, pages 271–282, 2015.

- [8] B. S. Baker. and M. Hill. Approximation algorithms for NP-complete problems on planar graphs. *Journal of the ACM*, 41(1):153–180, 1994.
- [9] A. Bar-Noy, P. Cheilaris, S. Olonetsky, and S. Smorodinsky. Online conflict-free colouring for hypergraphs. *Combinatorics, Probability and Computing*, 19(04):493–516, 2010.
- [10] P. Cheilaris, L. Gargano, A. A. Rescigno, and S. Smorodinsky. Strong conflict-free coloring for intervals. *Algorithmica*, 70(4):732–749, 2014.
- [11] P. Cheilaris, S. Smorodinsky, and M. Sulovsky. The potential to improve the choice: list conflict-free coloring for geometric hypergraphs. In *Proc. 27th Annual Symposium on Computational Geometry*, pages 424–432. ACM, 2011.
- [12] P. Cheilaris and G. Tóth. Graph unique-maximum and conflict-free colorings. *Journal of Discrete Algorithms*, 9(3):241–251, 2011.
- [13] K. Chen, A. Fiat, H. Kaplan, M. Levy, J. Matousek, E. Mossel, J. Pach, M. Sharir, S. Smorodinsky, U. Wagner, and E. Welzl. Online conflict-free coloring for intervals. *SIAM J. Computing*, 36:1342–1359, 2007.
- [14] K. Elbassioni and N. H. Mustafa. Conflict-free colorings of rectangles ranges. In *Annual Symposium on Theoretical Aspects of Computer Science*, pages 254–263. Springer, 2006.
- [15] G. Even, Z. Lotker, D. Ron, and S. Smorodinsky. Conflict-free colorings of simple geometric regions with applications to frequency assignment in cellular networks. *SIAM Journal on Computing*, 33(1):94–136, 2003.
- [16] L. Gargano and A. A. Rescigno. Complexity of conflict-free colorings of graphs. *Theoretical Computer Science*, 566:39–49, 2015.
- [17] R. Glebov, T. Szabó, and G. Tardos. Conflict-free coloring of graphs. *Combinatorics, Probability and Computing*, 23:434–448, 2014.
- [18] H. Hadwiger. Über eine Klassifikation der Streckenkomplexe. *Vierteljschr. Naturforsch. Ges. Zürich*, 88:133–143, 1943.
- [19] S. Har-Peled and S. Smorodinsky. Conflict-free coloring of points and simple regions in the plane. *Discrete & Computational Geometry*, 34(1):47–70, 2005.
- [20] F. Hoffmann, K. Kriegel, S. Suri, K. Verbeek, and M. Willert. Tight bounds for conflict-free chromatic guarding of orthogonal art galleries. In *31st International Symposium on Computational Geometry*, volume 34 of *LIPICs*, pages 421–435, 2015.
- [21] E. Horev, R. Krakovski, and S. Smorodinsky. Conflict-free coloring made stronger. In *Proc. 12th Scandinavian Symposium and Workshop on Algorithm Theory*, volume 6139, pages 105–117, 2010.
- [22] T. Kikuno, N. Yoshida, and Y. Kakuda. A linear algorithm for the domination number of a series-parallel graph. *Discrete Applied Mathematics*, 1983.
- [23] N. Lev-Tov and D. Peleg. Conflict-free coloring of unit disks. *Discrete Applied Mathematics*, 157(7):1521–1532, 2009.
- [24] W. Mulzer and G. Rote. Minimum-weight triangulation is NP-hard. *Journal of the ACM*, 55(2):11, 2008.
- [25] J. Pach and G. Tárdoš. Conflict-free colourings of graphs and hypergraphs. *Combinatorics, Probability and Computing*, 18(05):819–834, Sept. 2009.
- [26] N. Robertson, D. Sanders, P. Seymour, and R. Thomas. The four-colour theorem. *J. Combinatorial Theory Series B*, 70:2–44, 1997.
- [27] S. Smorodinsky. *Combinatorial Problems in Computational Geometry*. PhD thesis, School of Computer Science, Tel-Aviv University, 2003.
- [28] M. M. Sysło. Characterizations of outerplanar graphs. *Discrete Mathematics*, 26:47–53, 1979.
- [29] R. Wilson. *Four colours suffice: How the map problem was solved*. Princeton University Press, 2013.