



Semiconductor Research Corporation



Computing Research Association Women

Following Paths in Task Space:

Distance Metrics and Planning Algorithms

Rachel Holladay and Siddhartha Srinivasa

Personal Robotics Lab, Robotics Institute, CMU

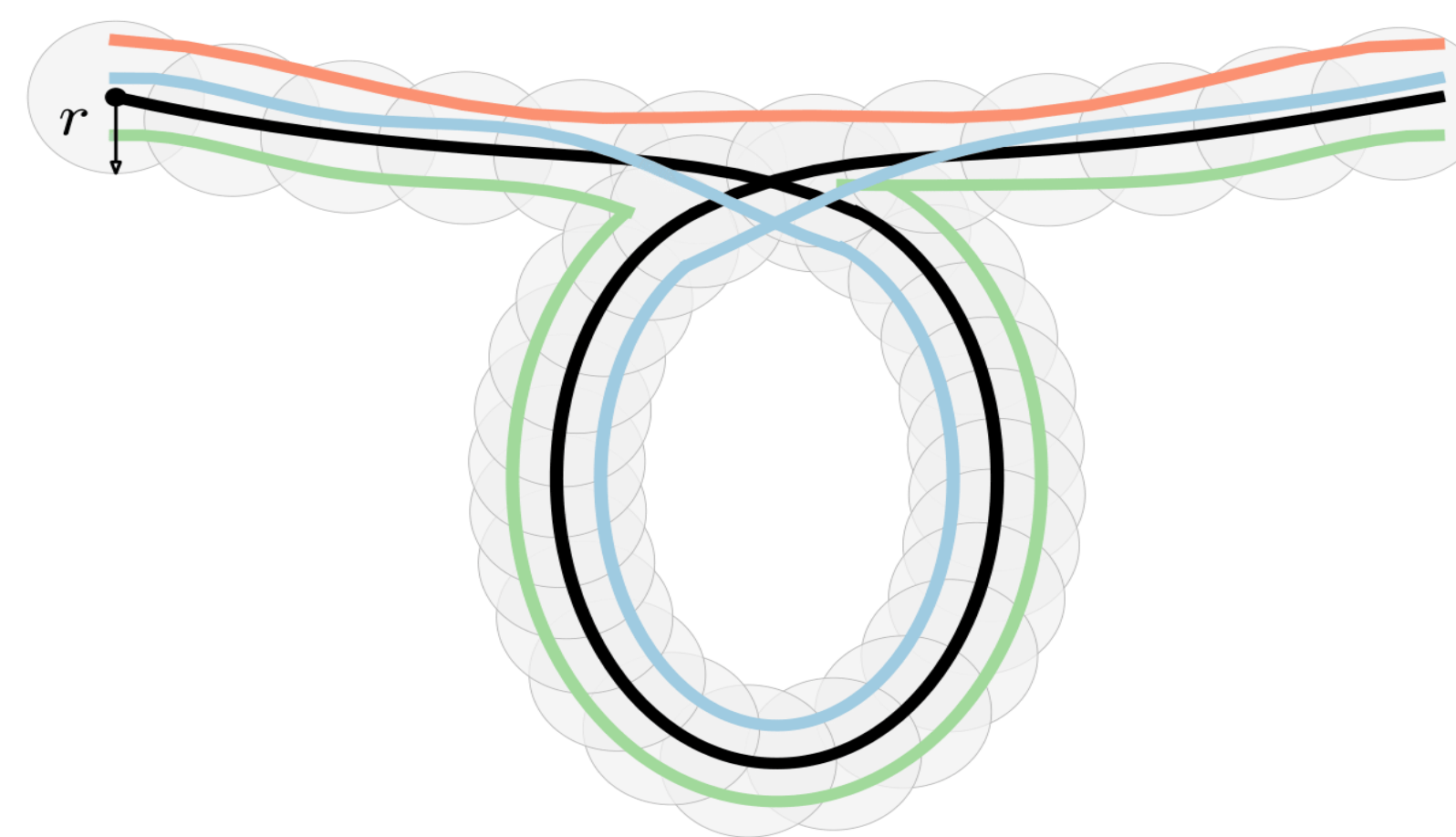
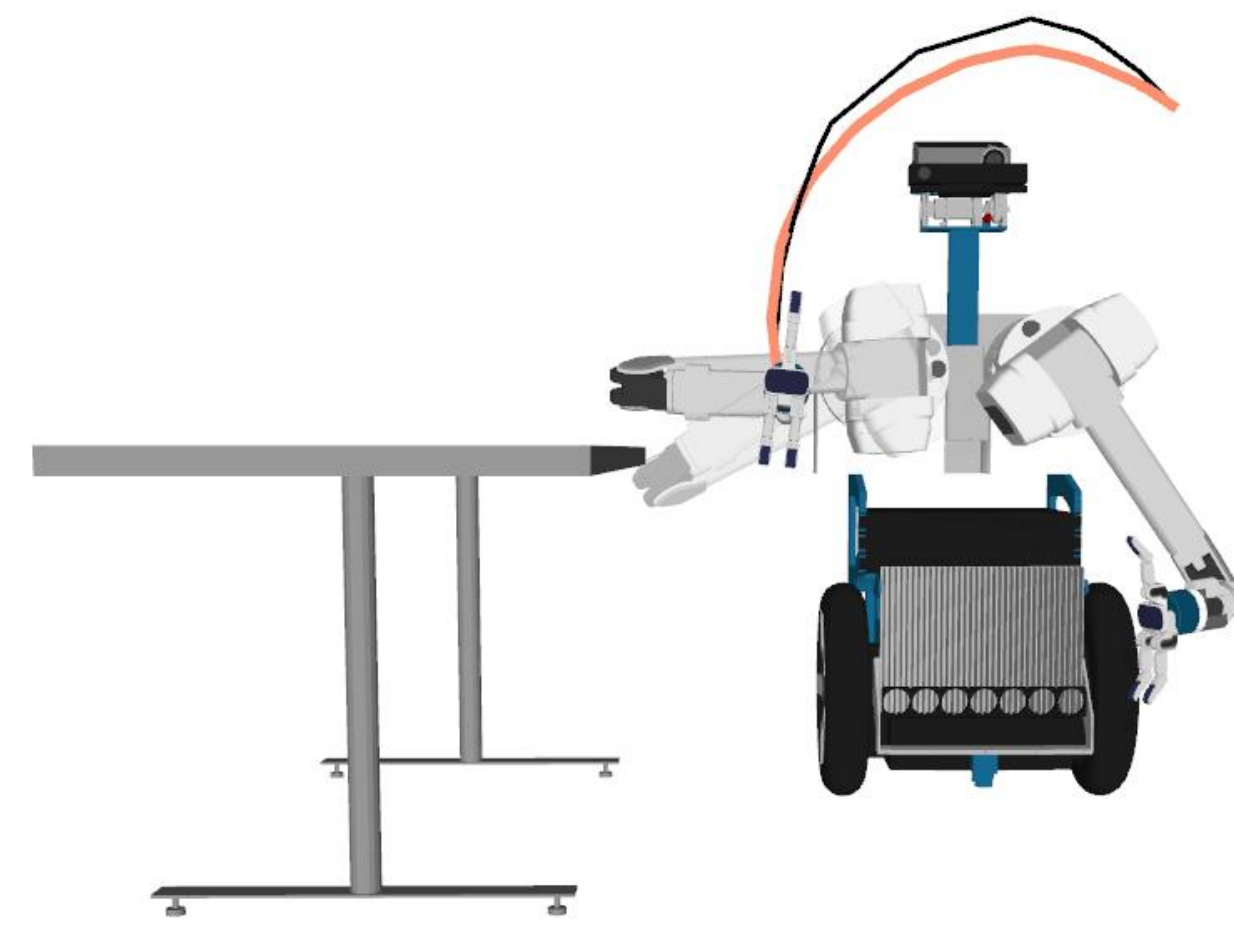
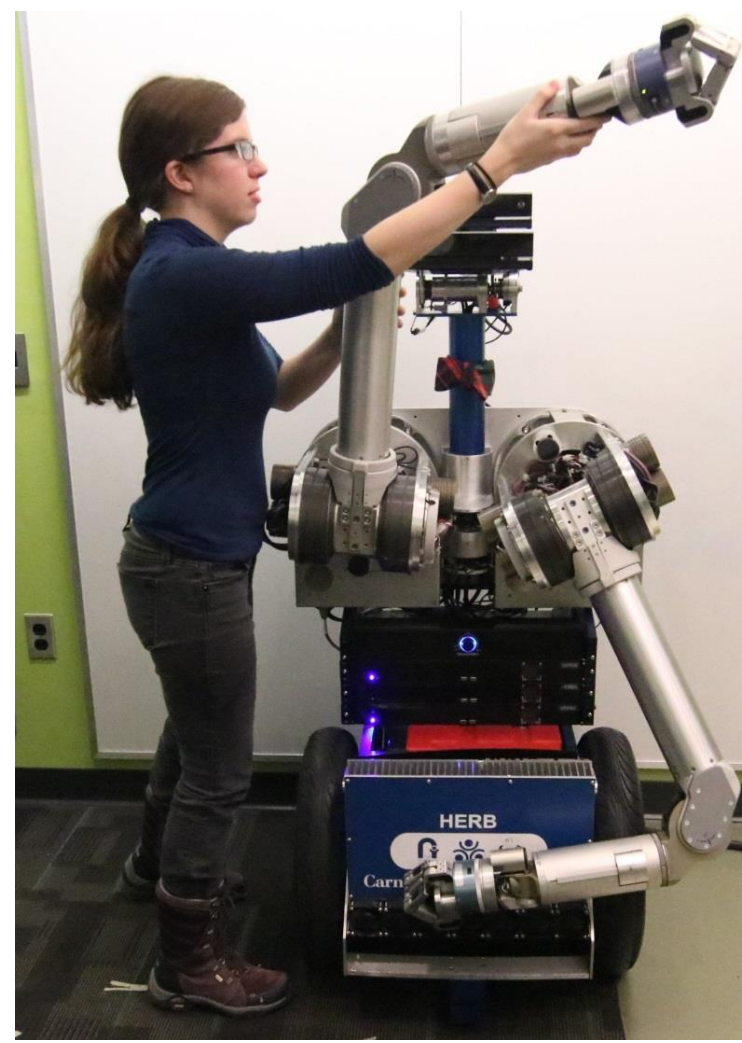
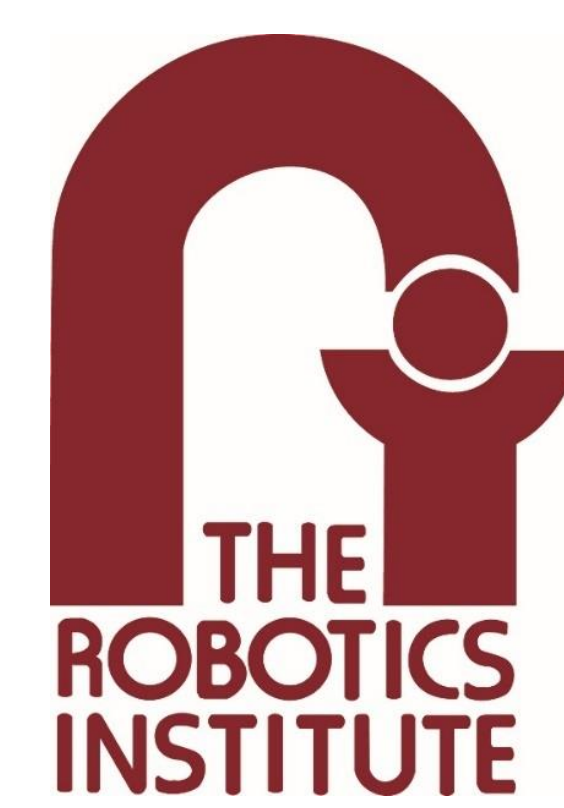

$$H(\xi_x, \bar{\xi}_x) = \sup_{y \in \xi} \inf_{\bar{y} \in \bar{\xi}} d_{TS}(y, \bar{y})$$

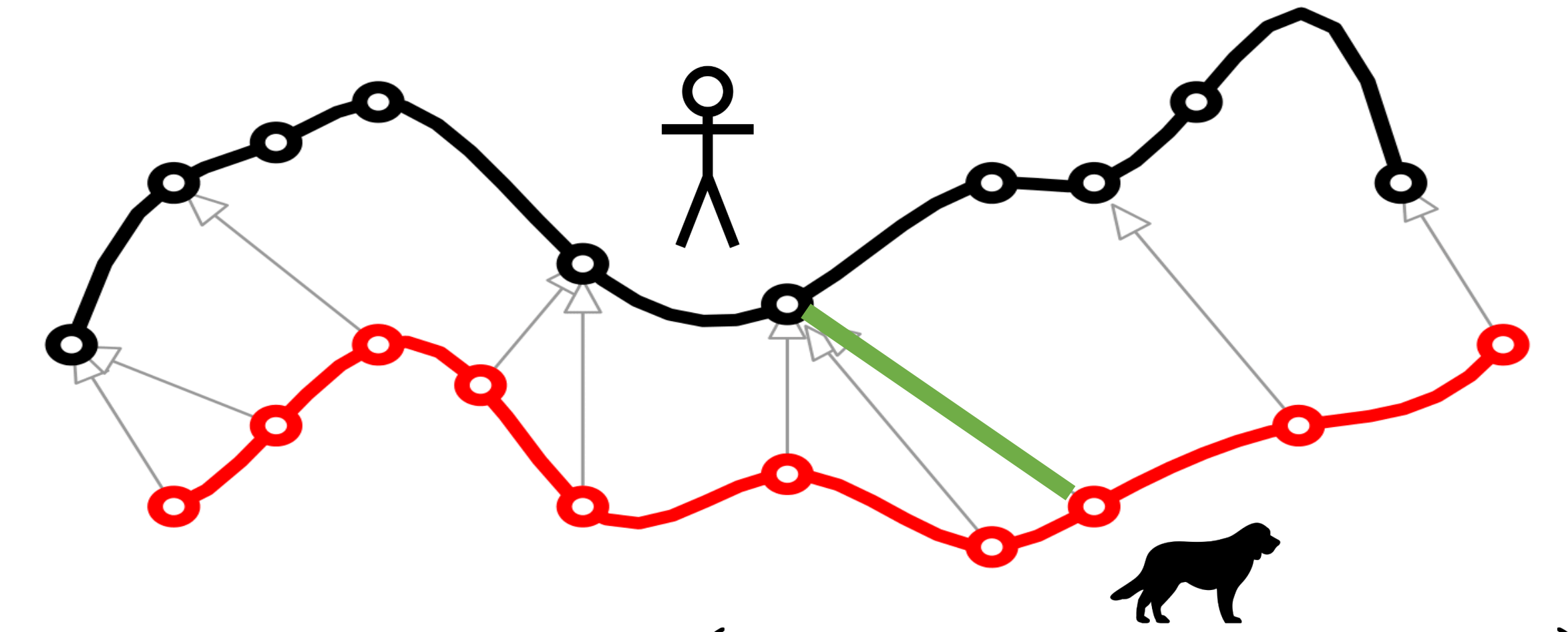

$$F(\xi_x, \bar{\xi}_x) = \inf_{\alpha, \beta} \max_{t \in [0,1]} \left\{ d_{TS}(\xi_x(\alpha(t)), \bar{\xi}_x(\beta(t))) \right\}$$

$$\xi^* = \arg \min_{\xi \in \Xi} \|\xi - \bar{\xi}\| \quad \text{s.t. constraints}$$

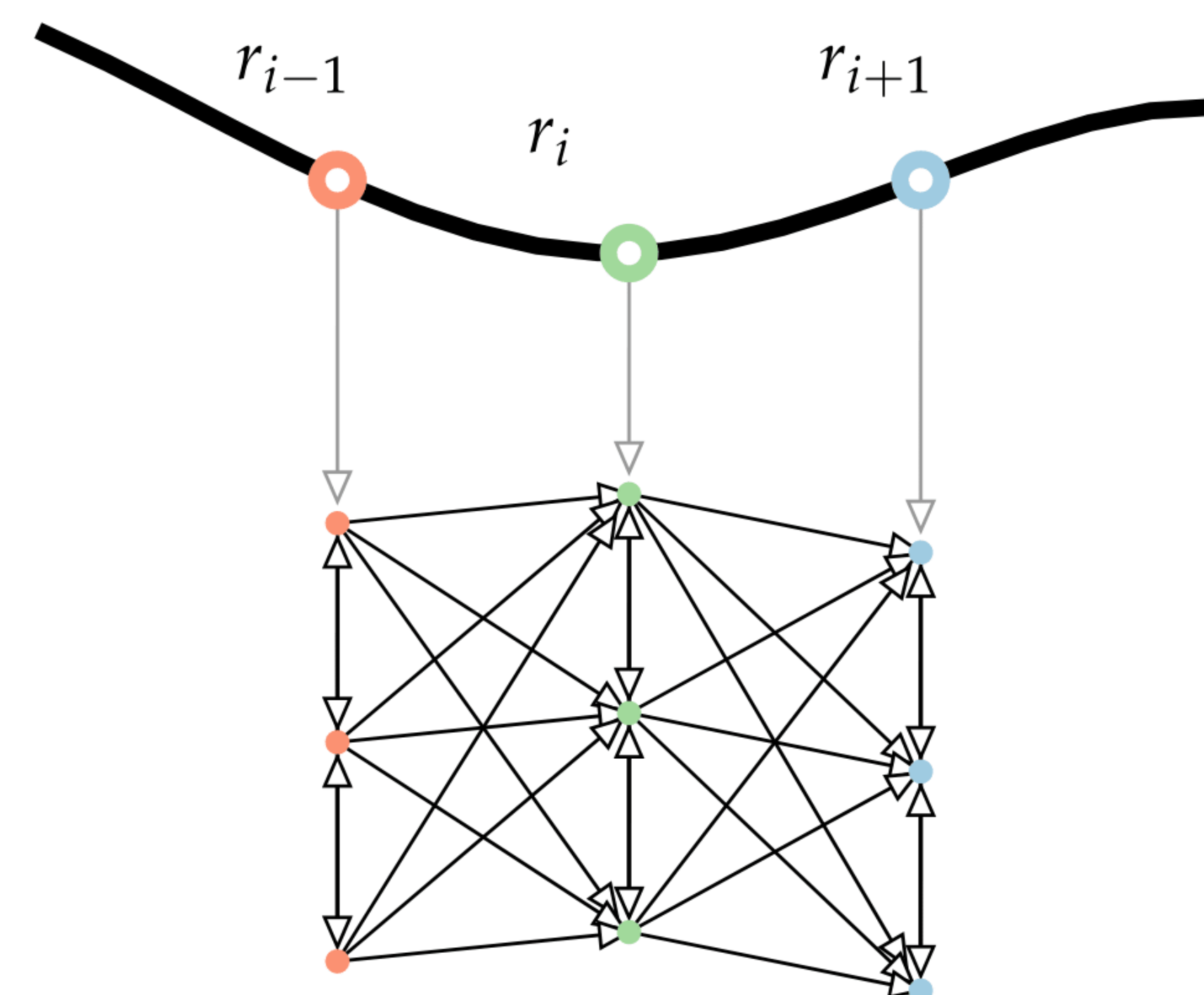
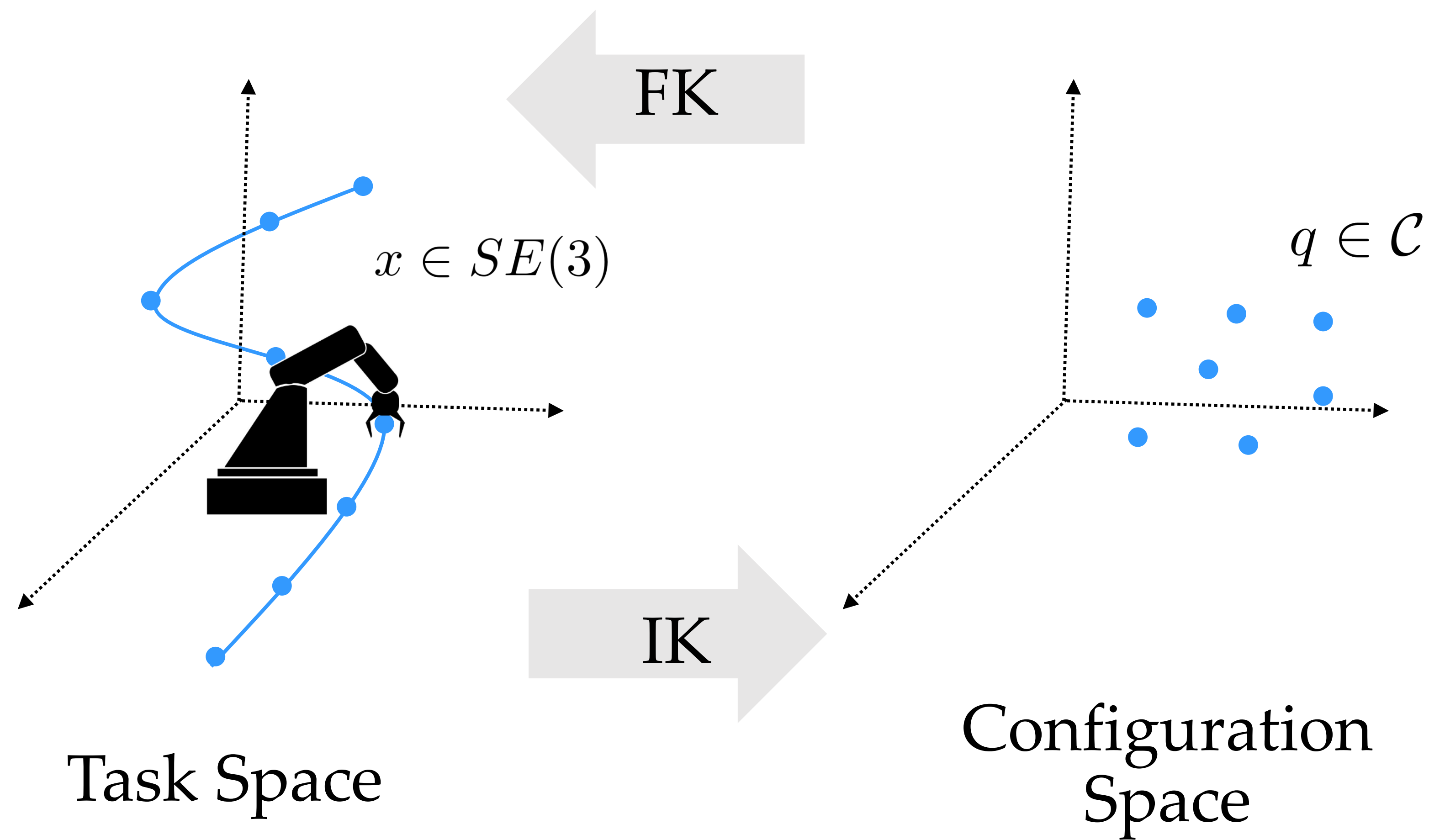

$$S = \{q \in \mathcal{C} \mid FK(q) \in \bar{\xi}\}$$

$$S = \bigcup_{\alpha \in [0,1]} IK(\bar{\xi}(\alpha))$$

Search Cross Product Space

